Description

Features.

- ◆ Super high Flux output and high Luminance
- ◆ Designed for high current operation
- ◆ Low thermal resistance:12°C/W
- ◆ SMT solder bility
- ◆ RoHS compliant

Applications.

- ◆ General Illumination
- ◆ Outdoor & Indoor architectural lighting
- ◆ Decorative lighting
- ◆ Portable lighting and Reading lighting
- ◆ Traffic signaling

Table of Contents

Outline Dimensions

Parameters

Typical Characteristic Curves (1)

Typical Characteristic Curves (2)

Soldering Condition

Outline Dimensions

1、 Dome Type

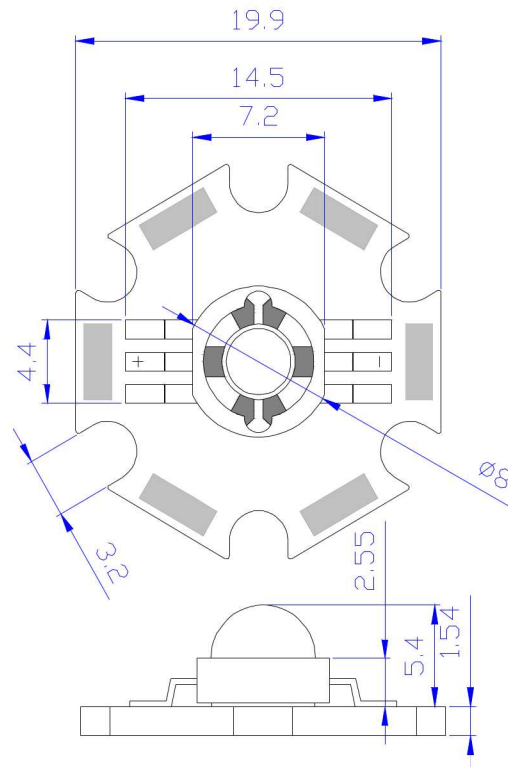

2、 Circuit diagram

INTERNAL CIRCUIT DIAGRAM

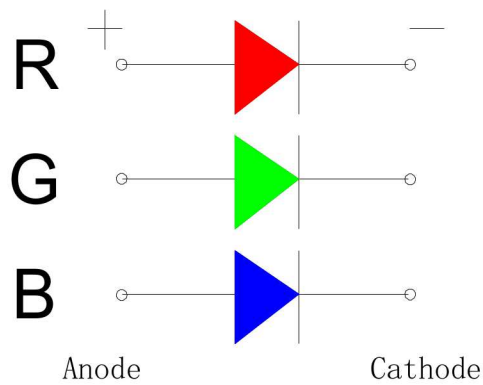

Notes

1. All dimensions are in millimeters.(tolerance:±0.2)
2. Dimension Scale:1:1

*The appearance and specifications of the product may be changed for improvement without notice.

Parameters

Electrical-Optical Characteristics at IF=750mA, Ta=25°C

Parameter	Symbol	Min	Typ	Max	Unit	
Luminous Flux	ϕ_v	R	60	~	80	lm
		G	120	~	130	
		B	30	~	50	
Correlated Wavelength	λ_D	R	620	~	630	nm
		G	520	~	530	
		B	460	~	470	
Forward Voltage	V_F	R	2.2	~	2.8	V
		G	3.5	~	4.5	
		B	3.5	~	4.5	
Power Dissipation	P_D	~	9	~	W	
View Angle	2 θ 1/2	~	120	~	deg.	
Thermal Resistance	$R\theta_{J-B}$	~	4	~	°C/W	

Absolute Maximum Ratings

Parameter	Symbol	Value	Unit	
Forward Current	I_F	R	800	mA
		G	750	
		B	750	
Junction Temperature	T_j	115	°C	
Operating Temperature	T_{opr}	-40~+60	°C	
Storage Temperature	T_{stg}	0~+60	°C	
ESD Sensitivity	~	±2,000V HBM	~	
Temperature Coefficient of voltage	~	-5	mV/°C	
DC Pulse Current(@ 1 KHz,10% duty cycle)	I_{FP}	1000	mA	
Reverse Voltage	V_R	Not designed for reverse operation		

*Notes

1. Tolerance of Luminous Flux is ±3%
2. Tolerance of Forward Voltage is ±0.1V

Typical Characteristic Curves(1)

1. Typical Light Distribution Curve

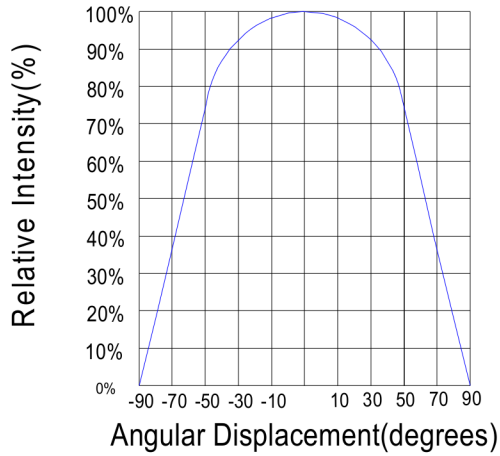

2. Typical Light-Emitting Angle Radiation Pattern

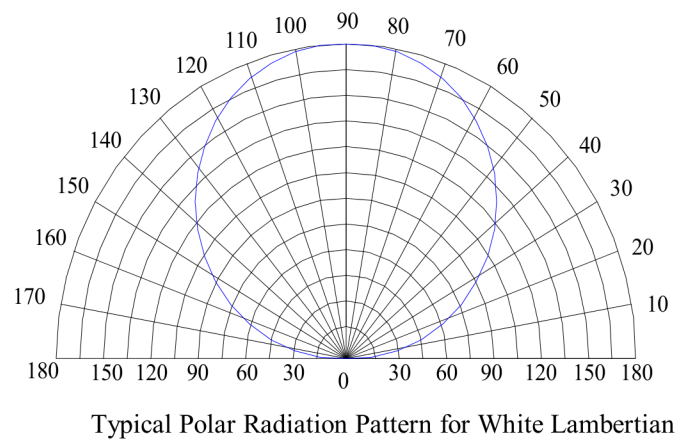

3. Forward Current vs. Relative Luminous Flux Curve

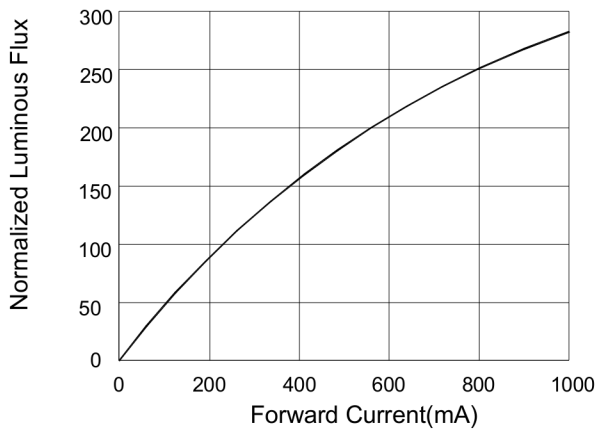

4. Forward Current Derating Curve, Derating based on $T_{max}=125^{\circ}C$

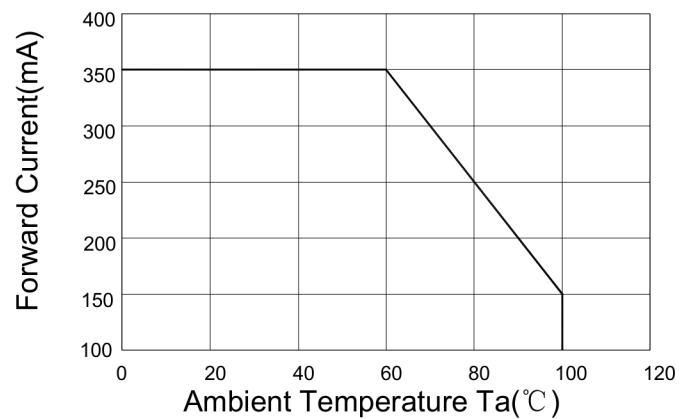

5. Electrical Characteristics Curve

5-1. White, Royal Blue, Blue, Green

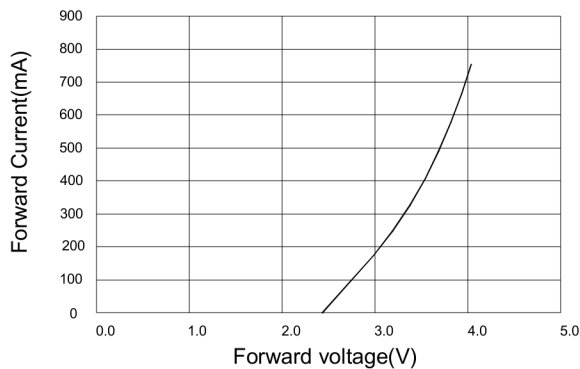

5-2. Amber, Red

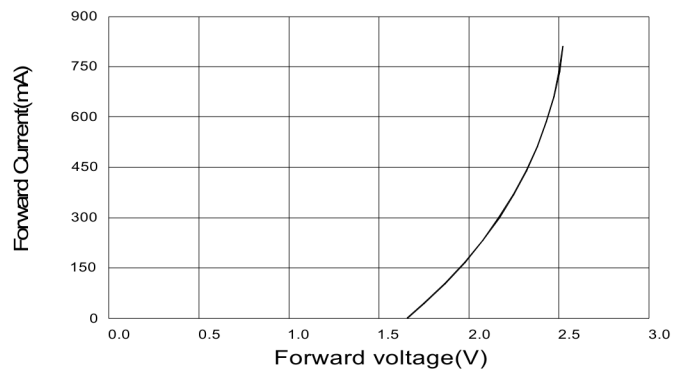

Typical Characteristic Curves(2)

6-1. Relative Flux vs. Junction Temperature (If = 350 mA)
White, Royal Blue, Blue, Green

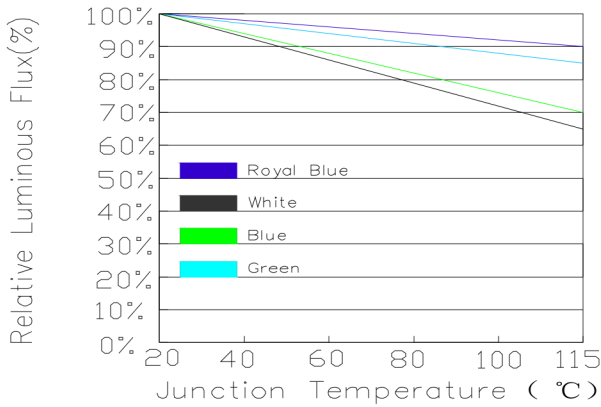

6-2. Relative Flux vs. Junction Temperature (If = 400 mA)
Amber, Red

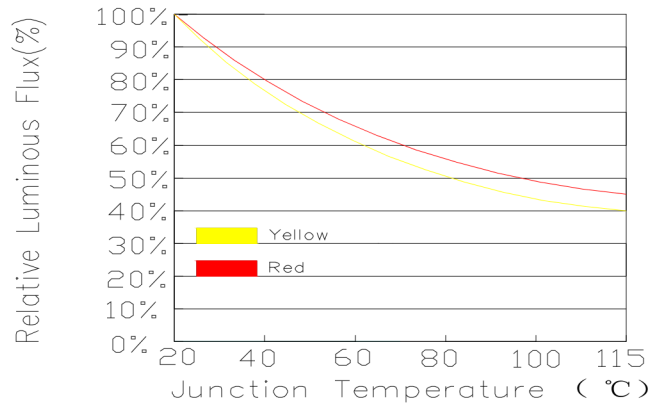

7. Typical white spectral distribution

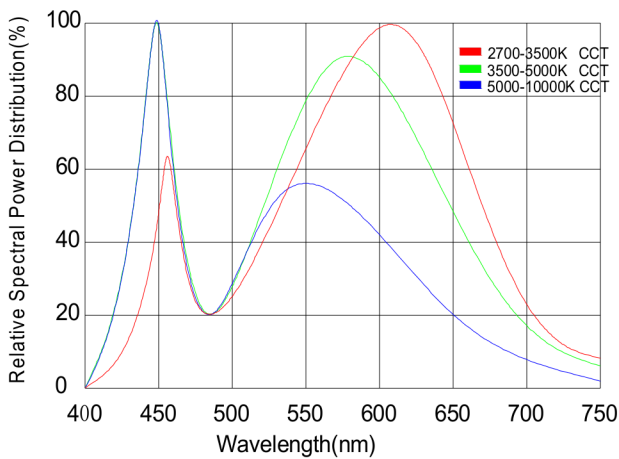

8. Relative Spectral Power Distribution

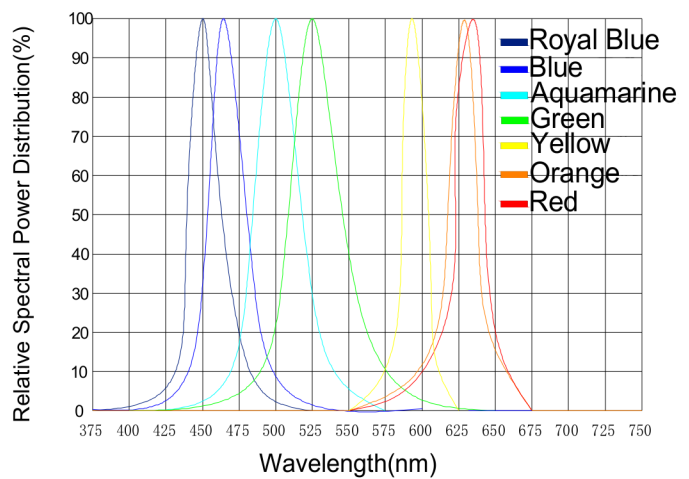

9. Reflow temperature time curve

Reflow Soldering Profile — Lead Free Solder

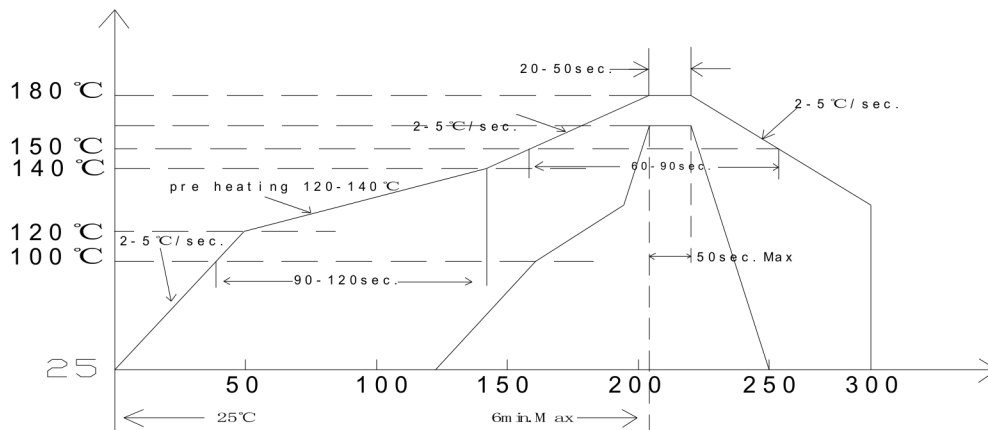

Soldering Condition

Reflow Soldering			Manual Welding	
	High temperature PC lens	Molding products	Temperature	Soldering time
Preheat	100-140°C	180-200°C	Highest 350°C	3ses once
Heatup time	120sec Max	120sec Max		
Peak temperature	180°C Max	260°C Max		
Condition of Soldering time	50sec Max	10sec Max		

*Notes

Conventional PC lens products don't use reflow soldering.