

---

## Description

### Features.

- ◆ Super high Flux output and high Luminance
- ◆ Designed for high current operation
- ◆ Low thermal resistance:12°C/W
- ◆ SMT solder bility
- ◆ RoHS compliant

### Applications.

- ◆ General Illumination
- ◆ Outdoor & Indoor architectural lighting
- ◆ Decorative lighting
- ◆ Portable lighting and Reading lighting
- ◆ Traffic signaling

## Table of Contents

Outline Dimensions

Parameters

Typical Characteristic Curves (1)

Typical Characteristic Curves (2)

Reliability Test

Soldering Condition./Packing Dimention.

---

---

## Outline Dimensions

### 1、 Dome Type

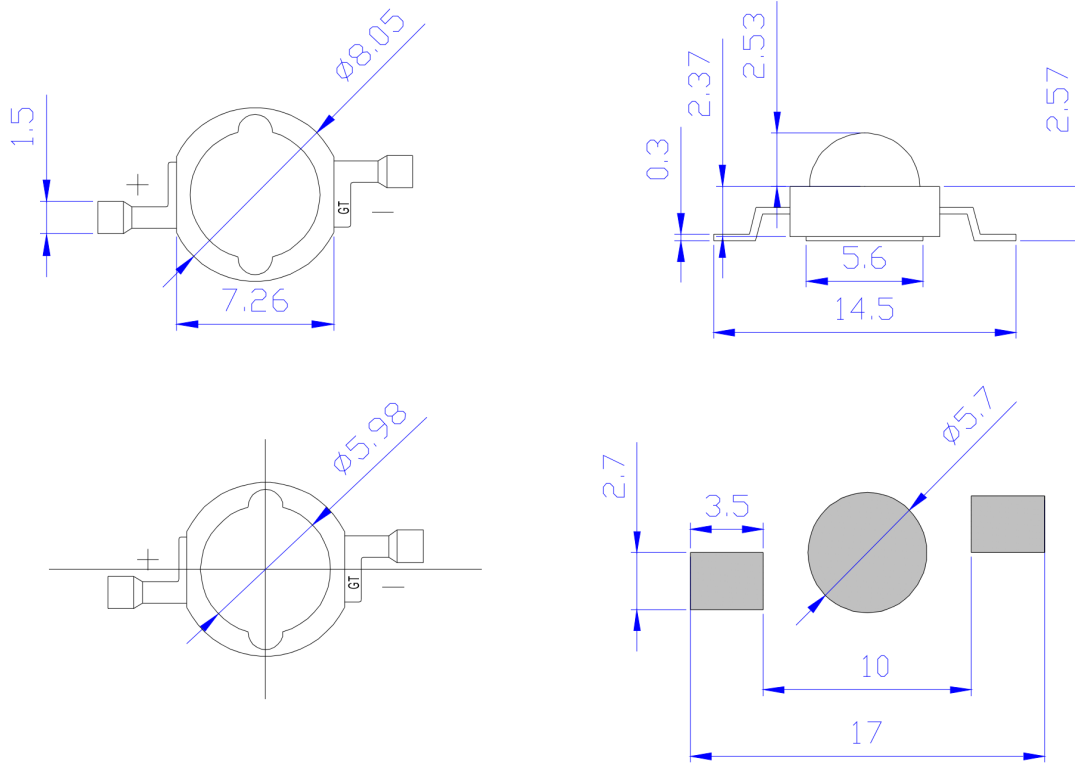

### 2、 Circuit diagram

INTERNAL CIRCUIT DIAGRAM

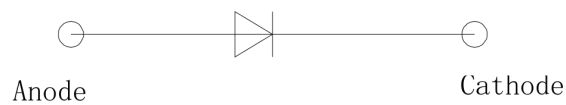

#### Notes

1. All dimensions are in millimeters.(tolerance: $\pm 0.2$ )
2. Dimension Scale: 1:1

\*The appearance and specifications of the product may be changed for improvement without notice.

## Parameters

### Electrical-Optical Characteristics at IF=750mA, Ta=25°C

Parameter	Symbol	Min	Typ	Max	Unit
Radiation flux	$\phi_e$	900	~	1000	mw
Wavelength	$\lambda_D$	430	~	435	nm
Forward Voltage	$V_F$	3.5	~	4.5	V
Power Dissipation	$P_D$	2.63	~	3.38	W
View Angle	2 $\theta$ /2	~	120	~	deg.
Thermal Resistance	$R\theta_{J-B}$	~	12	~	°C/W

### Absolute Maximum Ratings

Parameter	Symbol	Value	Unit
Forward Current	$I_F$	750	mA
Junction Temperature	$T_j$	115	°C
Operating Temperature	$T_{opr}$	-40~+60	°C
Storage Temperature	$T_{stg}$	0~+60	°C
ESD Sensitivity	~	±2,000V HBM	~
Temperature Coefficient of voltage	~	-5	mV/°C
DC Pulse Current(@ 1 KHz, 10% duty cycle)	$I_{FP}$	1000	mA
Reverse Voltage	$V_R$	Not designed for reverse operation	

\*Notes

1. Tolerance of Luminous Flux is ±3%.
2. Tolerance of Forward Voltage is ±0.1V.

# Typical Characteristic Curves(1)

1. Typical Light Distribution Curve

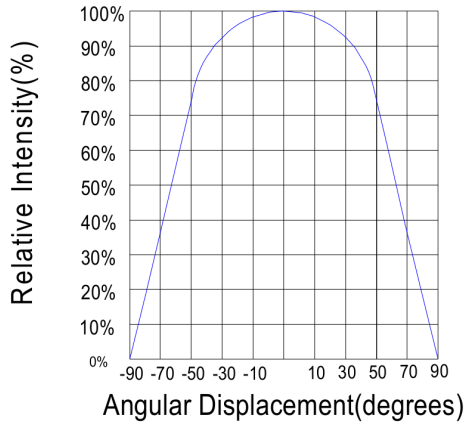

2. Typical Light-Emitting Angle Radiation Pattern

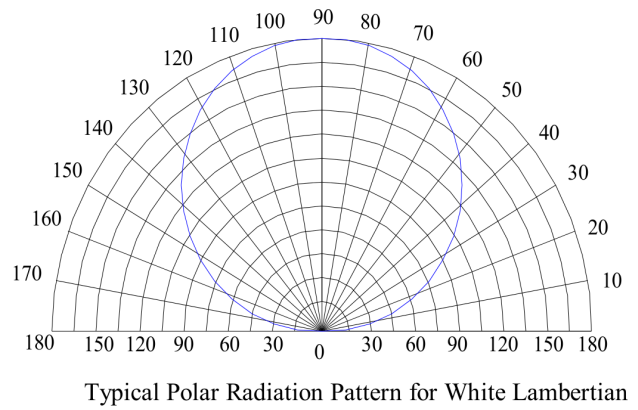

3. Forward Current vs. Relative Luminous Flux Curve

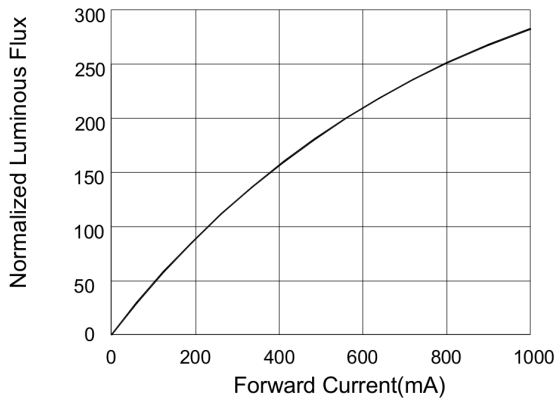

4. Forward Current Derating Curve, Derating based on  $T_{max}=125^{\circ}C$

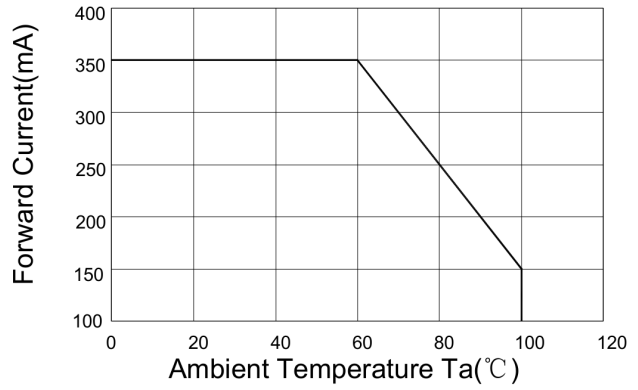

5. Electrical Characteristics Curve

5-1. White, Royal Blue, Blue, Green

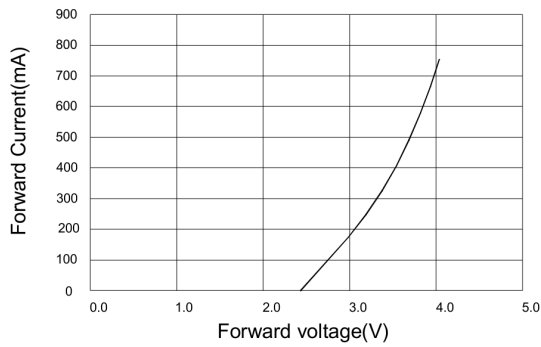

5-2. Amber, Red

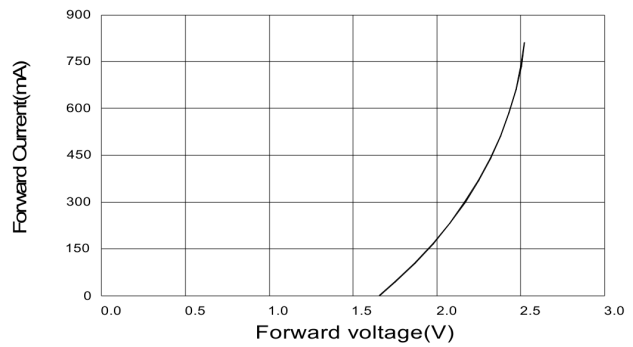

# Typical Characteristic Curves(1)

1. Typical Light Distribution Curve

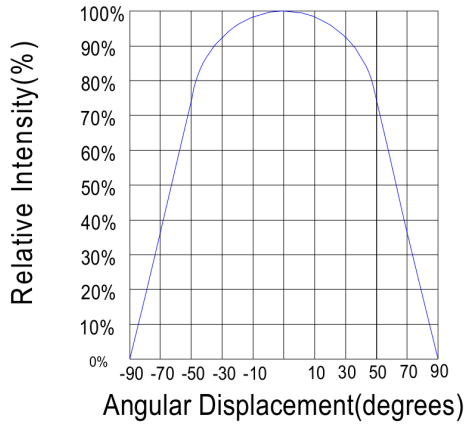

2. Typical Light-Emitting Angle Radiation Pattern

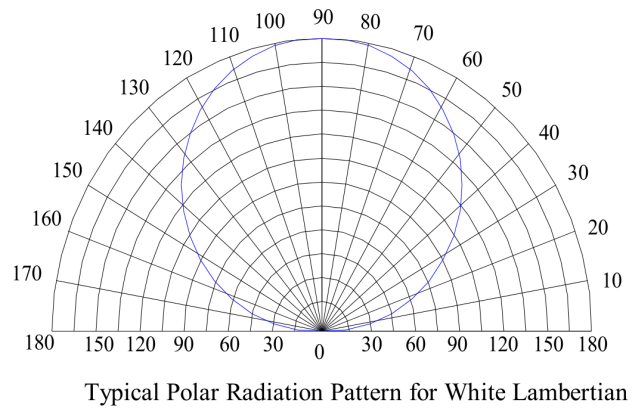

Typical Polar Radiation Pattern for White Lambertian

3. Forward Current vs. Relative Luminous Flux Curve

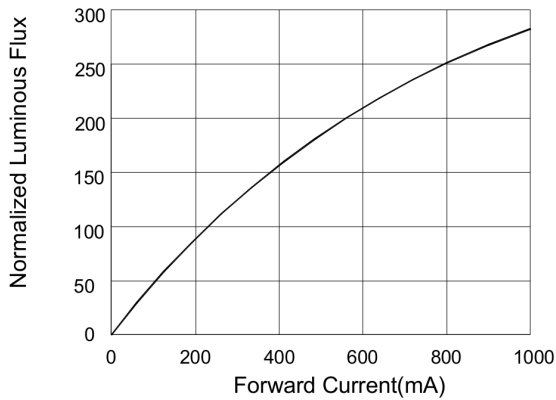

4. Forward Current Derating Curve, Derating based on  $T_{max}=125^{\circ}C$

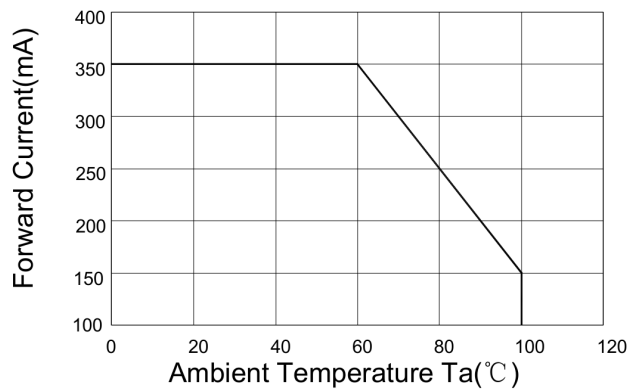

5. Electrical Characteristics Curve

5-1. White, Royal Blue, Blue, Green

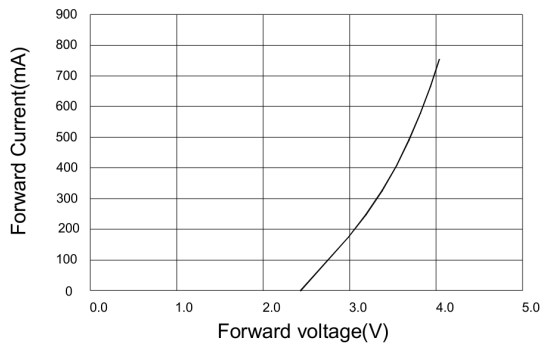

5-2. Amber, Red

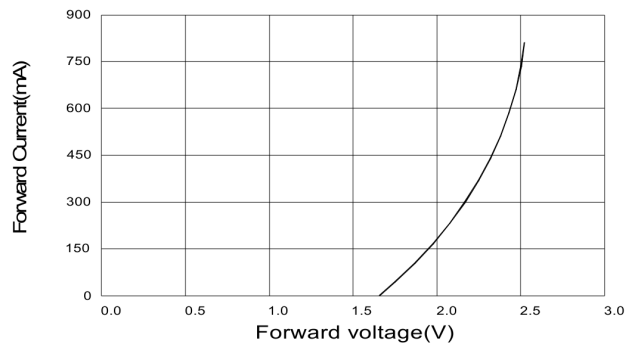

## Typical Characteristic Curves(2)

6-1. Relative Flux vs. Junction Temperature (If = 350 mA)  
White, Royal Blue, Blue, Green

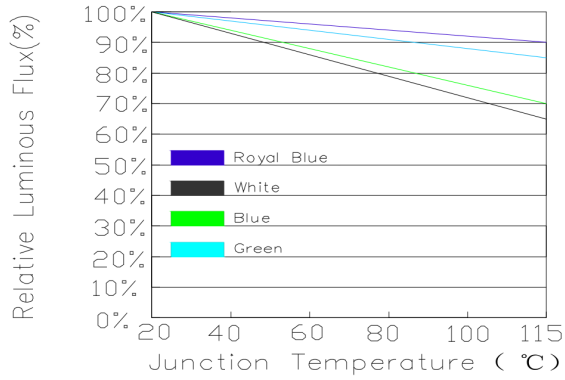

6-2. Relative Flux vs. Junction Temperature (If = 400 mA)  
Amber, Red

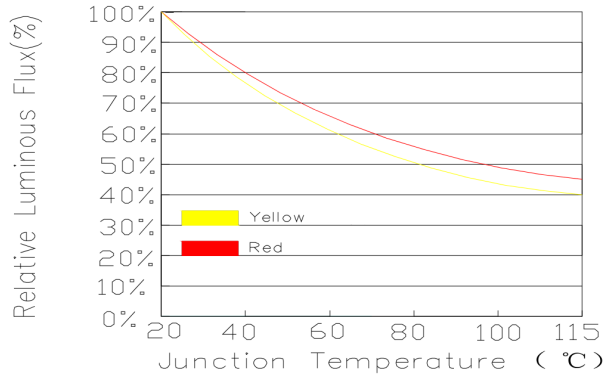

7. Typical white spectral distribution

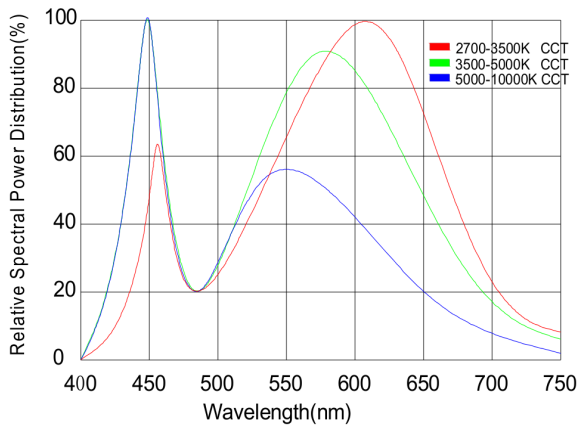

8. Relative Spectral Power Distribution

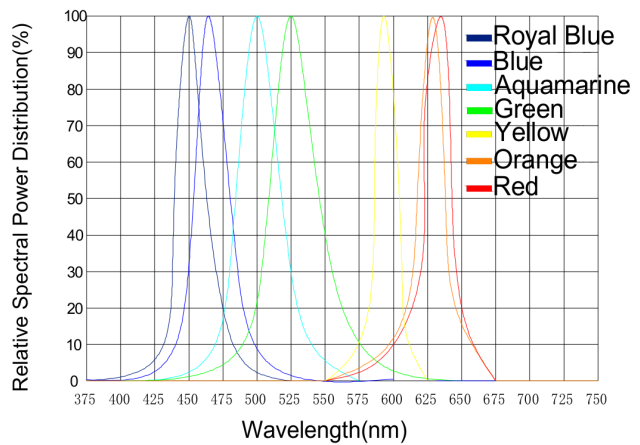

9. Reflow temperature time curve

### Reflow Soldering Profile — Lead Free Solder

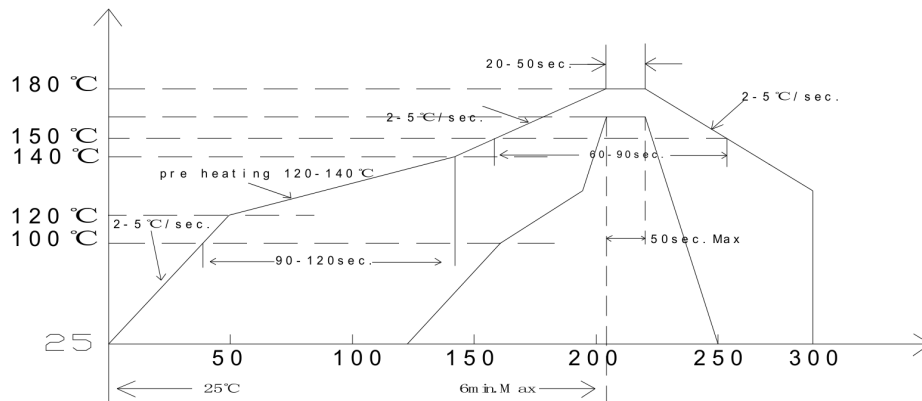

## Reliability Test Items And Conditions

Test Items	Test Condition	Test Hours Cycles	Sample Size	Ac/Re
<b>DC Aging</b>	Ta=25℃ IF=750mA	1000H	22	0/1
<b>Hot and cold shock</b>	-40℃/30min +100℃/30min	100Cycles	22	0/1
<b>High Temperature Storage</b>	Ta=100℃	1000H	22	0/1
<b>High Temperature High Humidity</b>	85℃/85%RH	1000H	22	0/1
<b>Low Temperature Storage</b>	Ta=-40℃	1000H	22	0/1
<b>ESD(HBM)</b>	2000V HBM	1Time	10	0/1

## Criteria For Judging the Damage

Items	Symbol	Test Condition	Criteria For Judging Damage
Forward Voltage	V <sub>F</sub>	I <sub>F</sub> =750mA	Initial Data±10%
Reverse Current	I <sub>R</sub>	V <sub>R</sub> =5V	I <sub>R</sub> ≤10μA
Luminous Flux	φ <sub>v</sub>	I <sub>F</sub> =750mA	Average φ <sub>v</sub> degradation≤20% Single LED φ <sub>v</sub> degradation≤30%

## Soldering Condition

Reflow Soldering			Manual Welding	
	High temperature PC lens	Molding products	Temperature	Soldering time
Preheat	100-140°C	180-200°C	Highest 350°C	3ses once
Heatup time	120sec Max	120sec Max		
Peak temperature	180°C Max	260°C Max		
Condition of Soldering time	50sec Max	10sec Max		

\*Notes

Conventional PC lens products don't use reflow soldering.