Description

Features.

- ◆ Super high Flux output and high Luminance
- ◆ Designed for high current operation
- ◆ Low thermal resistance:12°C/W
- ◆ SMT solder bility
- ◆ RoHS compliant

Applications.

- ◆ General Illumination
- ◆ Outdoor & Indoor architectural lighting
- ◆ Decorative lighting
- ◆ Portable lighting and Reading lighting
- ◆ Traffic signaling

Table of Contents

Outline Dimensions

Parameters

White Bining Information

Typical Characteristic Curves (1)

Typical Characteristic Curves (2)

Reliability Test

Soldering Condition

Outline Dimensions

1、 Dome Type

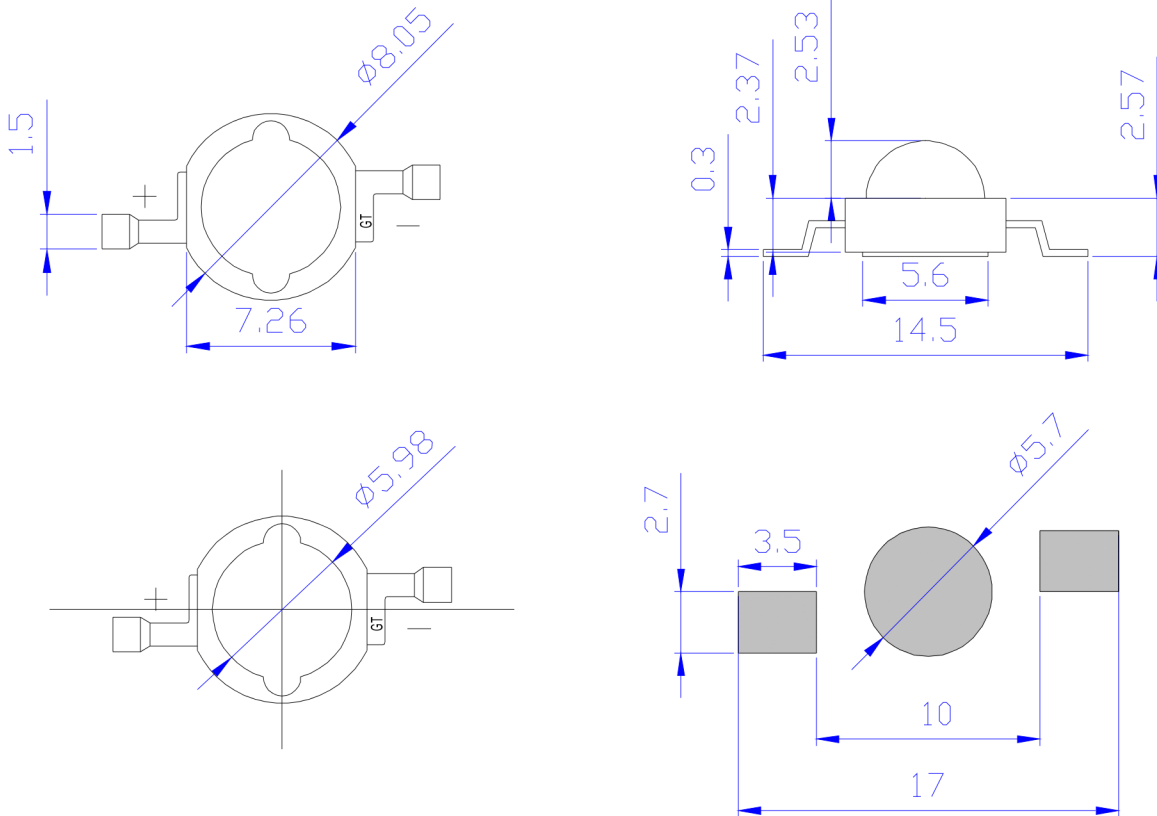

2、 Circuit diagram

INTERNAL CIRCUIT DIAGRAM

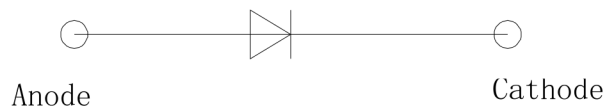

Notes

1. All dimensions are in millimeters.(tolerance: ± 0.2)
2. Dimension Scale:1:1

*The appearance and specifications of the product may be changed for improvement without notice.

Parameters

Electrical-Optical Characteristics at IF=750mA, Ta=25°C

Parameter	Symbol	Min	Typ	Max	Unit
Luminous Flux	ϕ_v	240	~	260	lm
Correlated Color Temperature	CCT	5500	~	6000	K
CRI	Ra	60	~	90	~
Forward Voltage	V _F	3.5	~	4.5	V
Power Dissipation	P _D	2.63	~	3.38	W
View Angle	2 θ 1/2	~	120	~	deg.
Thermal Resistance	R θ J-B	~	12	~	°C/W

Absolute Maximum Ratings

Parameter	Symbol	Value	Unit
Forward Current	I _F	750	mA
Junction Temperature	T _j	115	°C
Operating Temperature	T _{opr}	-40~+60	°C
Storage Temperature	T _{stg}	0~+60	°C
ESD Sensitivity	~	±2,000V HBM	~
Temperature Coefficient of voltage	~	-5	mV/°C
DC Pulse Current(@ 1 KHz,10% duty cycle)	I _{FP}	1000	mA
Reverse Voltage	V _R	Not designed for reverse operation	

*Notes

1. Tolerance of Luminous Flux is ±3%.
2. Tolerance of Forward Voltage is ±0.1V.

White Bining Information

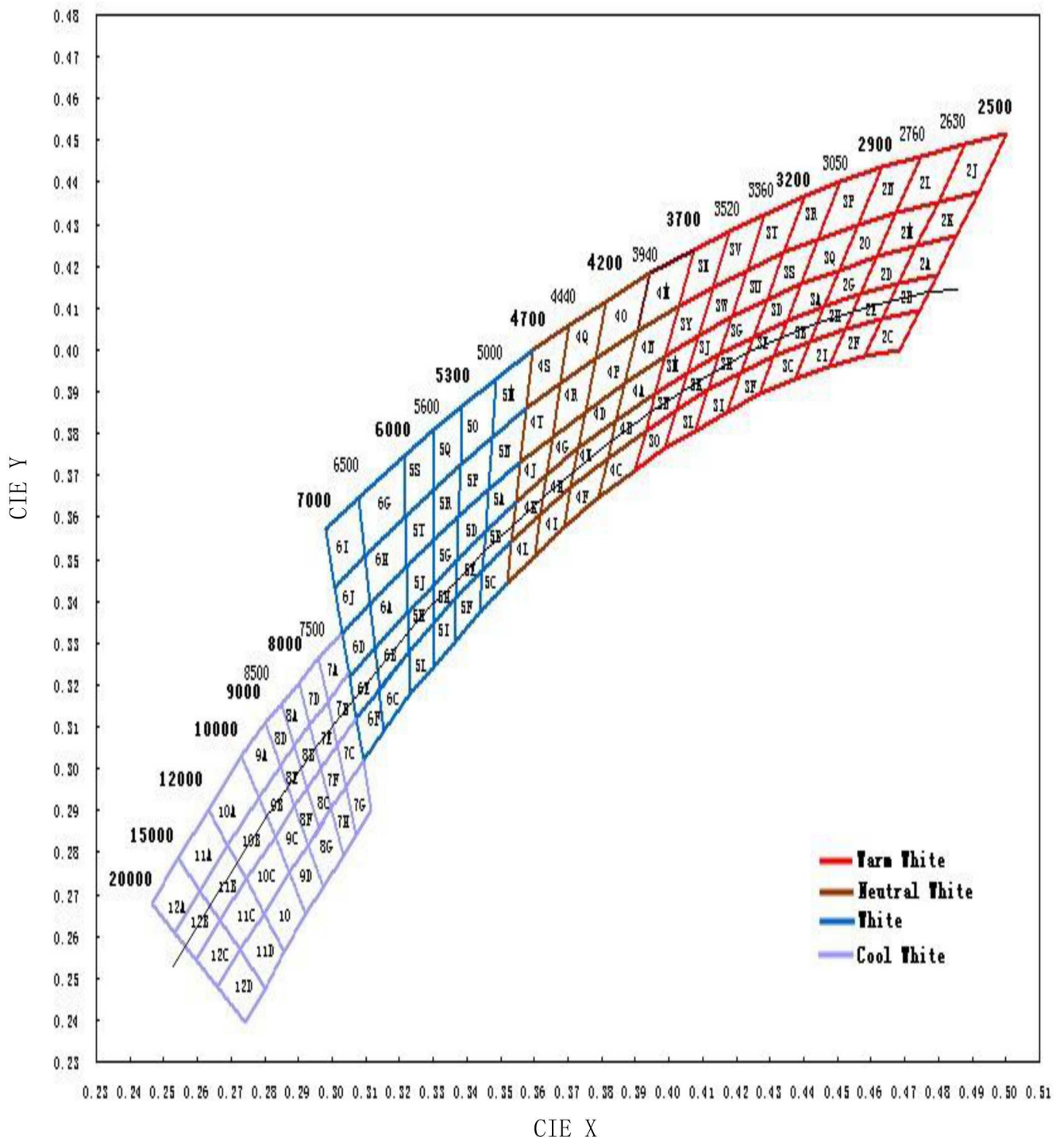

***Notes**

The black line represents the blackbody locus on CIE 1931 graph.

Typical Characteristic Curves(1)

1. Typical Light Distribution Curve

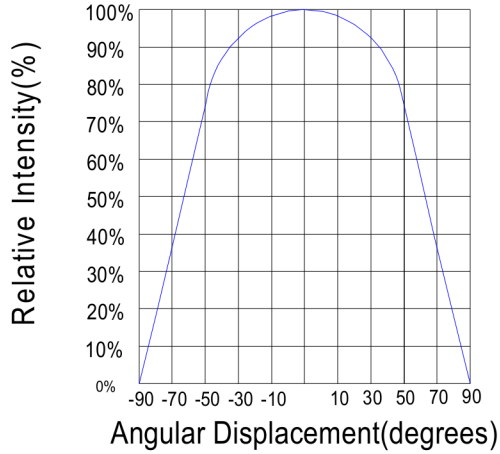

2. Typical Light-Emitting Angle Radiation Pattern

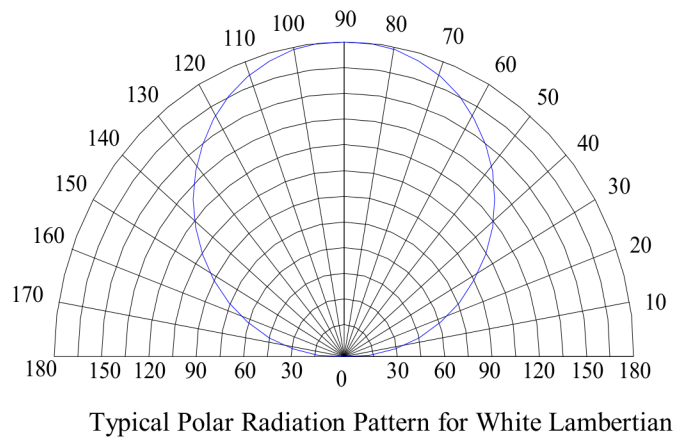

3. Forward Current vs. Relative Luminous Flux Curve

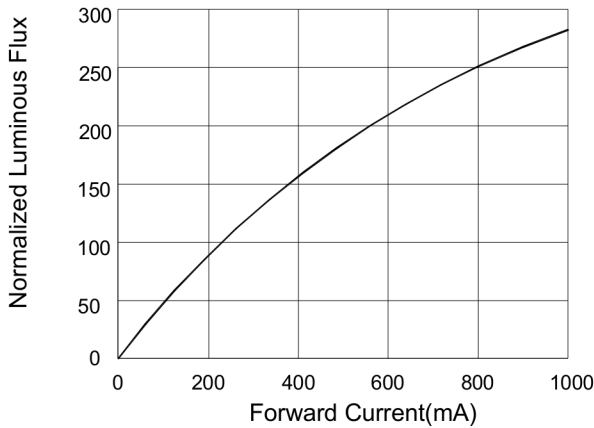

4. Forward Current Derating Curve, Derating based on $T_{max}=125^{\circ}C$

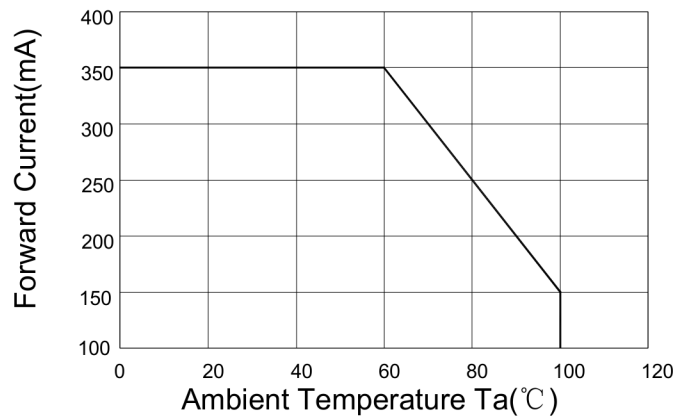

5. Electrical Characteristics Curve

5-1. White, Royal Blue, Blue, Green

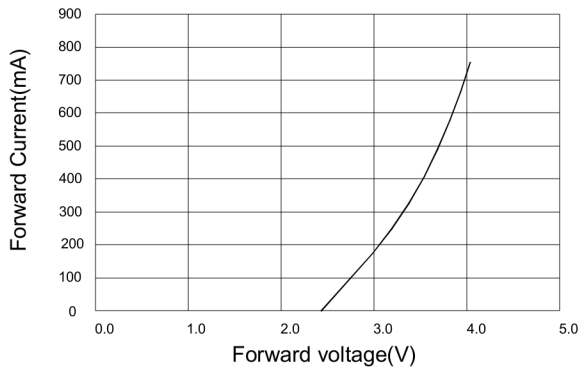

5-2. Amber, Red

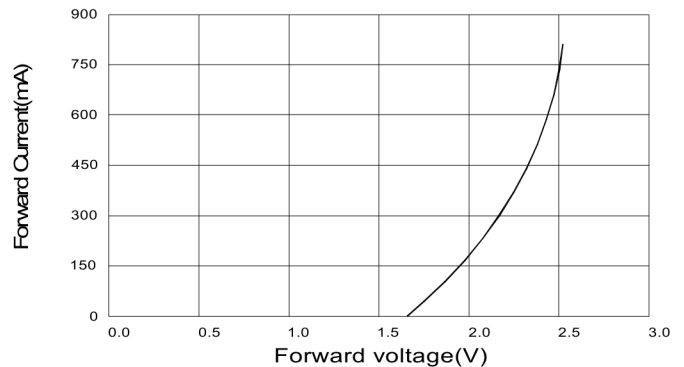

Typical Characteristic Curves(2)

6-1. Relative Flux vs. Junction Temperature (If = 350 mA)
White, Royal Blue, Blue, Green

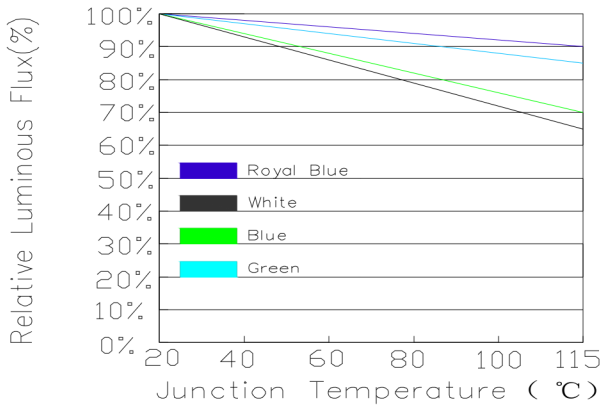

6-2. Relative Flux vs. Junction Temperature (If = 400 mA)
Amber, Red

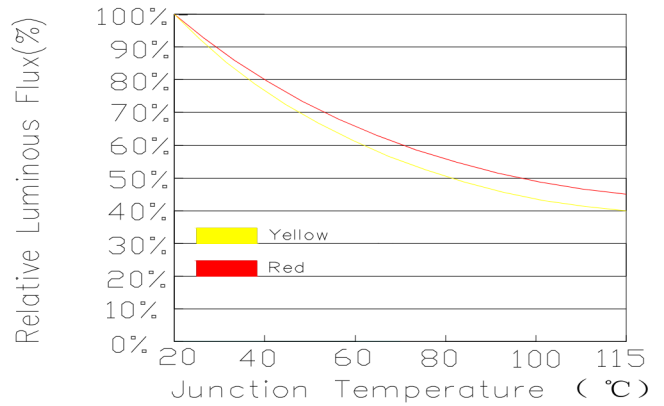

7. Typical white spectral distribution

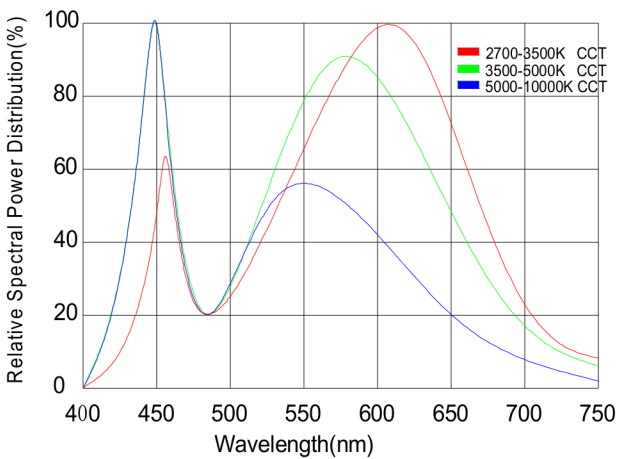

8. Relative Spectral Power Distribution

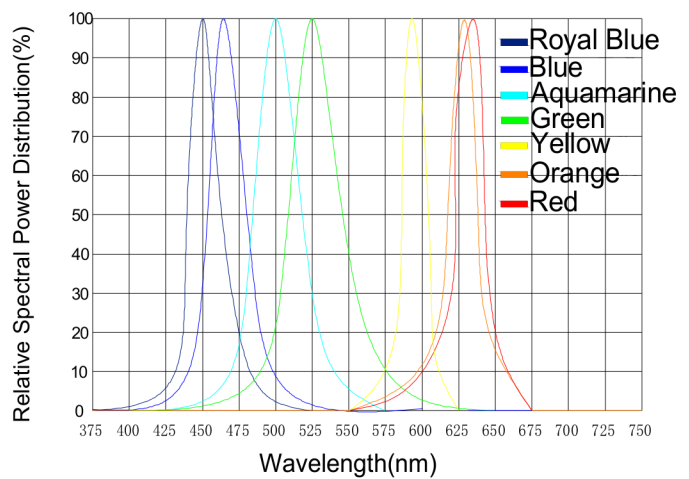

9. Reflow temperature time curve

Reflow Soldering Profile — Lead Free Solder

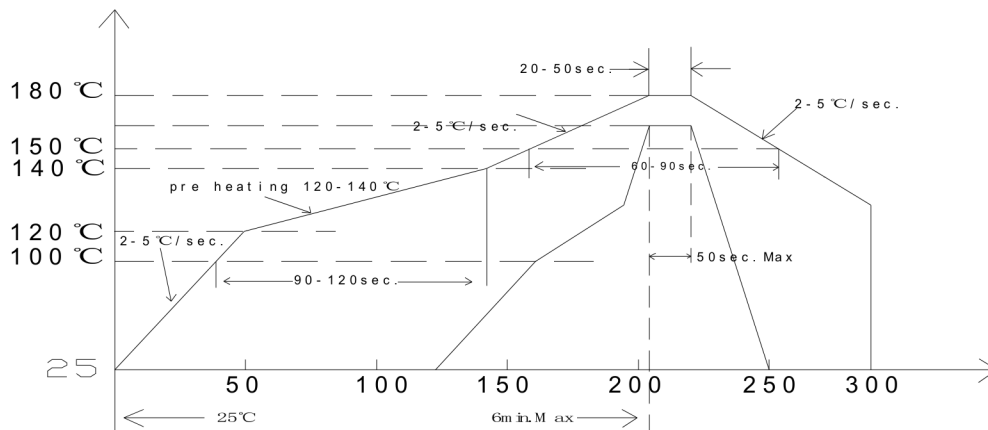

Reliability Test Items And Conditions

Test Items	Test Condition	Test Hours Cyles	Sample Size	Ac/Re
DC Aging	Ta=25℃ IF=750mA	1000H	22	0/1
Hot and cold shock	-40℃/30min +100℃/30min	100Cycles	22	0/1
High Temperature Storage	Ta=100℃	1000H	22	0/1
High Temperature High Humidity	85℃/85%RH	1000H	22	0/1
Low TemPerature Storage	Ta=-40℃	1000H	22	0/1
ESD(HBM)	2000V HBM	1Time	10	0/1

Criteria For Judging the Damage

Items	Symbol	Test Condition	Criteria For Judging Damage
Forward Voltage	V _F	I _F =750mA	Initial Data±10%
Reverse Current	I _R	V _R =5V	I _R ≤10μA
Luminous Flux	φ _v	I _F =750mA	Average φ _v degradation≤20% Single LED φ _v degradation≤30%

Soldering Condition

Reflow Soldering			Manual Welding	
	High temperature PC lens	Molding products	Temperature	Soldering time
Preheat	100-140°C	180-200°C	Highest 350°C	3ses once
Heatup time	120sec Max	120sec Max		
Peak temperature	180°C Max	260°C Max		
Condition of Soldering time	50sec Max	10sec Max		

*Notes

Conventional PC lens products don't use reflow soldering.